

Article number: 20192B48B48652BL

Description: E+G

T-angle clamps GN192-B48-B48-65-2-BL

Measures

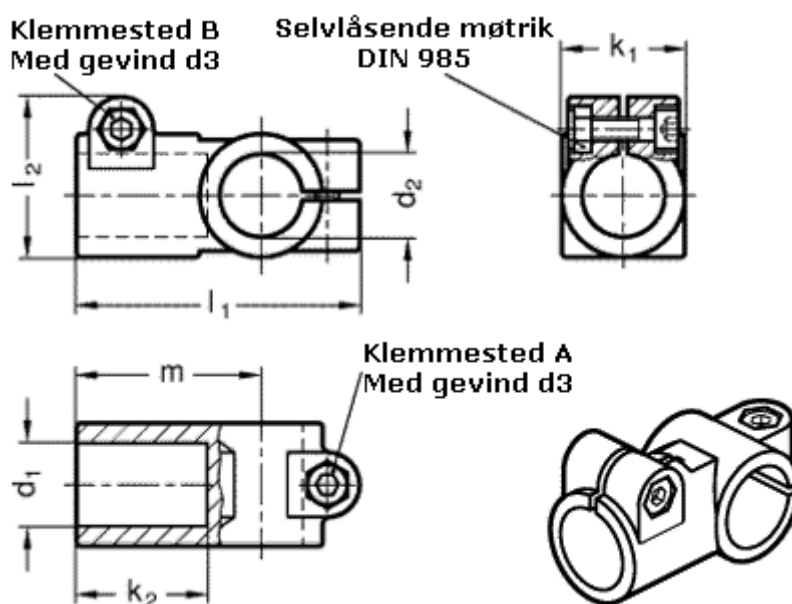

d1 = B48
d2 = B48
d3 = M10
k1 = 65
k2 = 75.0
l1 = 148
l2 = 77.5
m = 103